

HiPerFET™ Power MOSFET

H-Bridge Topology in ECO-PAC 2

N-Channel Enhancement Mode
High dv/dt, Low t_{rr} , HDMOS™ Family

$I_{D25} = 75 \text{ A}$
 $V_{DSS} = 100 \text{ V}$
 $R_{DSon} = 25 \text{ m}\Omega$
 $t_{rr} \leq 200 \text{ ns}$

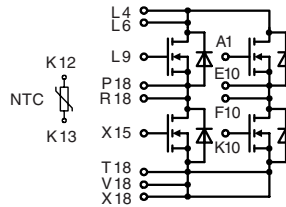

Pin arrangement see outlines

MOSFETs				
Symbol	Conditions	Maximum Ratings		
V_{DSS}	$T_J = 25^\circ\text{C}$ to 150°C	100	V	
V_{DGR}	$T_J = 25^\circ\text{C}$ to 150°C ; $R_{GS} = 1 \text{ M}\Omega$	100	V	
V_{GS}	Continuous	± 20	V	
V_{GSM}	Transient	± 30	V	
I_{D25}	$T_C = 25^\circ\text{C}$	75	A	
I_{DM}	$T_C = 25^\circ\text{C}$, pulse width limited by T_{JM}	300	A	
I_{AR}	$T_C = 25^\circ\text{C}$	75	A	
E_{AR}	$T_C = 25^\circ\text{C}$	30	mJ	
dv/dt	$I_S \leq I_{DM}$, $di/dt \leq 100 \text{ A}/\mu\text{s}$, $V_{DD} \leq V_{DSS}$, $T_J \leq 150^\circ\text{C}$, $R_G = 2 \Omega$	5	V/ns	
P_D	$T_C = 25^\circ\text{C}$	300	W	
Symbol	Conditions	Characteristic Values ($T_J = 25^\circ\text{C}$, unless otherwise specified)		
		min.	typ.	max.
V_{DSS}	$V_{GS} = 0 \text{ V}$, $I_D = 250 \mu\text{A}$	100		V
$V_{GS(th)}$	$V_{DS} = V_{GS}$, $I_D = 4 \text{ mA}$	2.0		V
I_{GSS}	$V_{GS} = \pm 20 V_{DC}$, $V_{DS} = 0$			± 100 nA
I_{DSS}	$V_{DS} = 0.8 \cdot V_{DSS}$; $T_J = 25^\circ\text{C}$ $V_{GS} = 0 \text{ V}$; $T_J = 125^\circ\text{C}$			250 μA 1 mA
$R_{DS(on)}$	$V_{GS} = 10 \text{ V}$, $I_D = 0.5 I_{D25}$ Pulse test, $t \leq 300 \mu\text{s}$, duty cycle $d \leq 2\%$			25 m Ω
g_{fs}	$V_{DS} = 10 \text{ V}$; $I_D = I_{D25}$, pulse test	25	30	S
C_{iss}	$V_{GS} = 0 \text{ V}$, $V_{DS} = 25 \text{ V}$, $f = 1 \text{ MHz}$		4500	pF
C_{oss}			1600	pF
C_{riss}			800	pF
$t_{d(on)}$	$V_{GS} = 10 \text{ V}$, $V_{DS} = 0.5 \cdot V_{DSS}$, $I_D = 0.5 I_{D25}$ $R_G = 2 \Omega$, (External)		20	30 ns
t_r			60	110 ns
$t_{d(off)}$			80	110 ns
t_f			60	90 ns
$Q_{g(on)}$	$V_{GS} = 10 \text{ V}$, $V_{DS} = 0.5 \cdot V_{DSS}$, $I_D = 0.5 I_{D25}$		180	260 nC
Q_{gs}			36	70 nC
Q_{gd}			85	160 nC
R_{thJC}	with heatsink compound (0.42 K/m.K; 50 μm)			0.5 KW
R_{thCK}		0.25		KW

Features

- HiPerFET™ technology
 - low R_{DSon}
 - low gate charge for high frequency operation
 - unclamped inductive switching (UIS) capability
 - dv/dt ruggedness
 - fast intrinsic reverse diode
- ECO-PAC 2 package
 - isolated back surface
 - enlarged creepage towards heatsink
 - application friendly pinout
 - low inductive current path
 - high reliability
 - solderable pins for PCB mounting

Applications

- drives and power supplies
- battery or fuel cell powered
- automotive, industrial vehicle etc.
- secondary side of mains power supplies

IXYS reserves the right to change limits, test conditions and dimensions.

Source-Drain Diode

Characteristic Values

($T_J = 25^\circ\text{C}$, unless otherwise specified)

Symbol	Conditions	Characteristic Values		
		min.	typ.	max.
I_S	$V_{GS} = 0\text{ V}$			75 A
I_{SM}	Repetitive;			300 A
V_{SD}	$I_F = I_{D25}$, $V_{GS} = 0\text{ V}$, Pulse test, $t \leq 300\ \mu\text{s}$, duty cycle $d \leq 2\%$			1.75 V
t_{rr}	$I_F = 25\text{ A}$, $-di/dt = 100\text{ A}/\mu\text{s}$, $T_J = 25^\circ\text{C}$ $V_R = 25\text{ V}$ $T_J = 125^\circ\text{C}$		300	200 ns ns

Temperature Sensor NTC

Symbol	Conditions	Characteristic Values		
		min.	typ.	max.
R_{25}	$T = 25^\circ\text{C}$	4.75	5.0	5.25 k Ω
$B_{25/50}$			3375	K

Module

Symbol	Conditions	Maximum Ratings	
T_{VJ}		-40...+150	$^\circ\text{C}$
T_{stg}		-40...+125	$^\circ\text{C}$
V_{ISOL}	$I_{ISOL} \leq 1\text{ mA}$; 50/60 Hz; $t = 1\text{ s}$	3600	V~
M_d	mounting torque (M4)	1.5 - 2.0 14 - 18	Nm lb.in.
a	Max. allowable acceleration	50	m/s^2

Symbol	Conditions	Characteristic Values		
		min.	typ.	max.
d_s	Creepage distance on surface (Pin to heatsink)	11.2		mm
d_A	Strike distance in air (Pin to heatsink)	11.2		mm
Weight		24		g

Data according to IEC 60747 refer to a single diode or transistor unless otherwise stated

Dimensions in mm (1 mm = 0.0394")

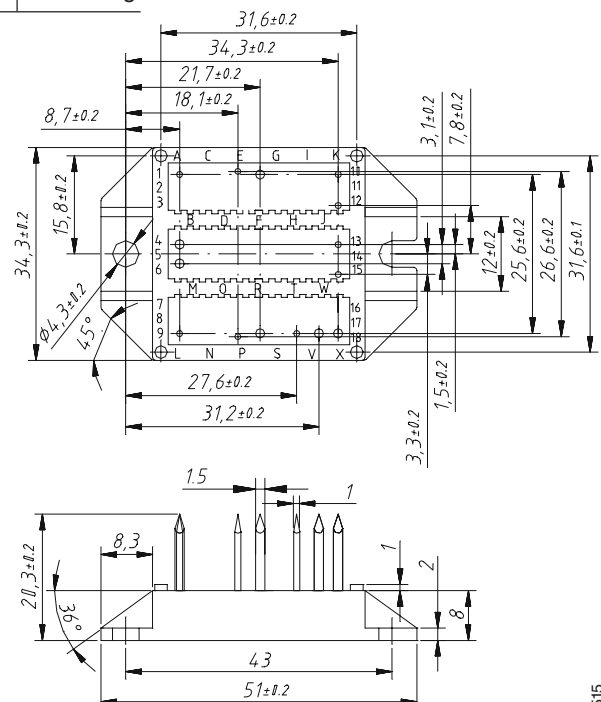

IXYS reserves the right to change limits, test conditions and dimensions.

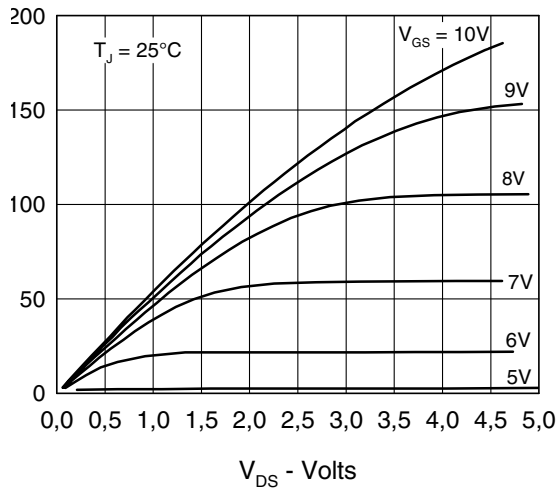

Fig. 1 Output Characteristics

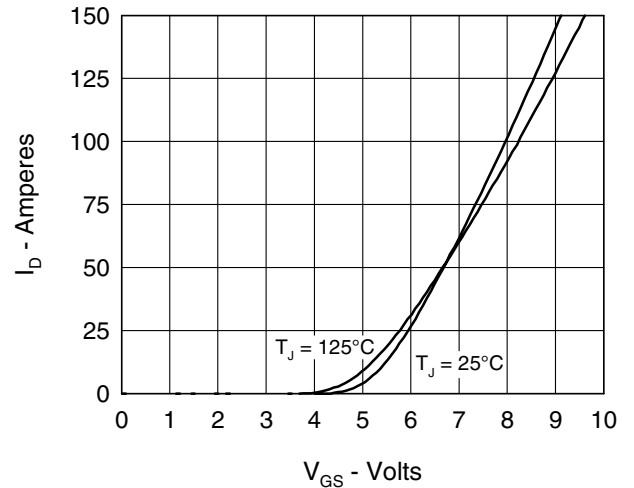

Fig. 2 Input Admittance

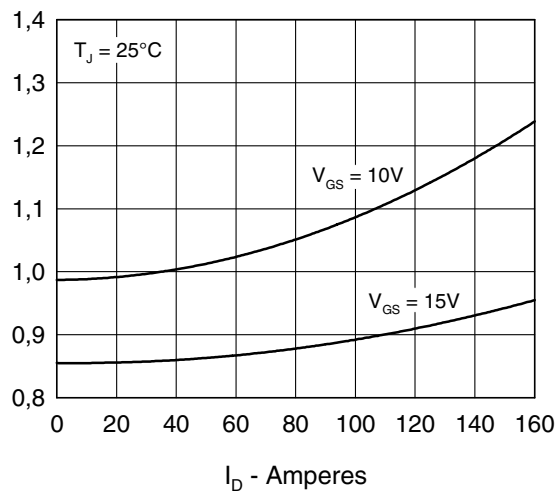

Fig. 3 $R_{DS(on)}$ vs. Drain Current

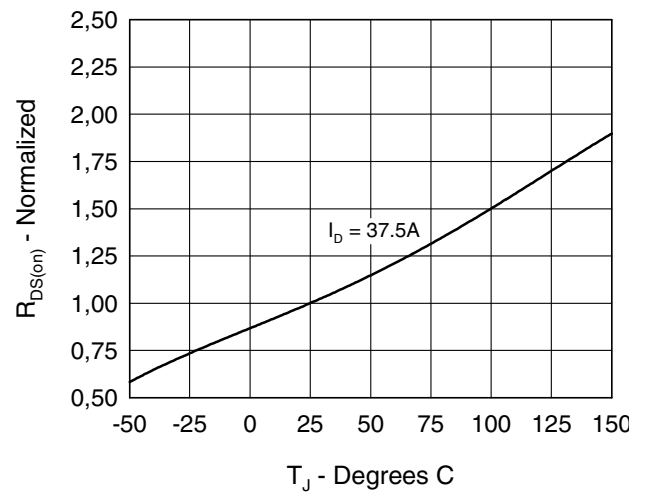

Fig. 4 Temperature Dependence of Drain to Source Resistance

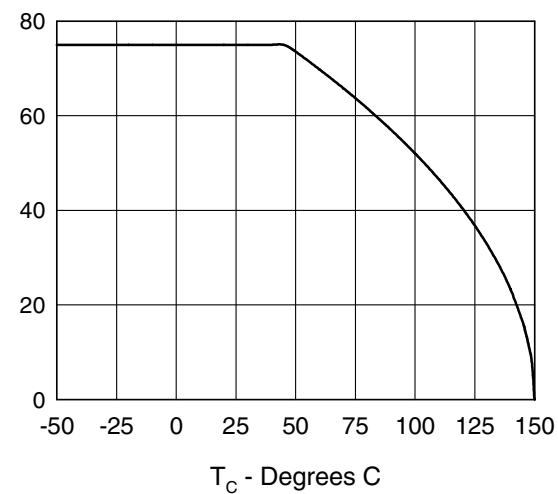

Fig. 5 Drain Current vs. Case Temperature

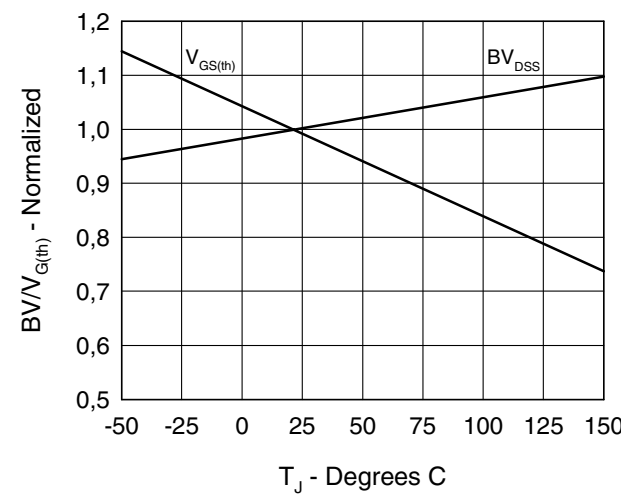

Fig. 6 Temperature Dependence of Breakdown and Threshold Voltage

IXYS reserves the right to change limits, test conditions and dimensions.

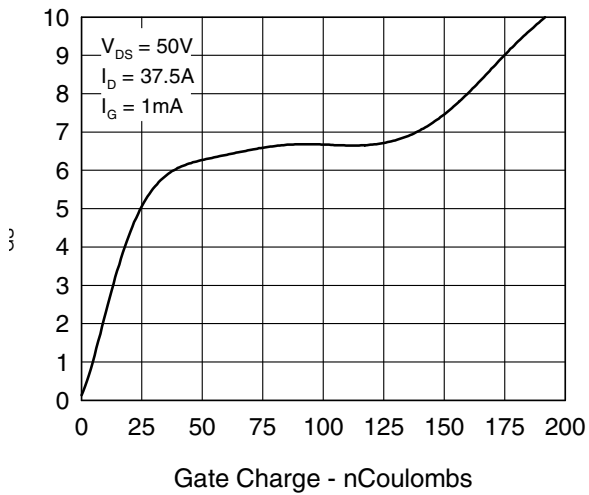

Fig.7 Gate Charge Characteristic Curve

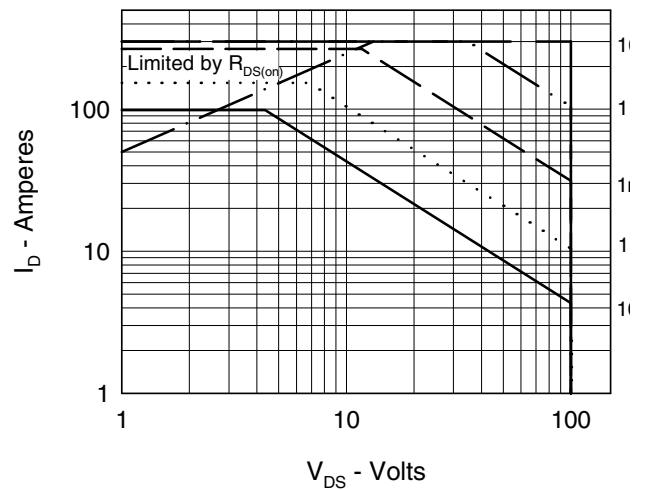

Fig.8 Forward Bias Safe Operating Area

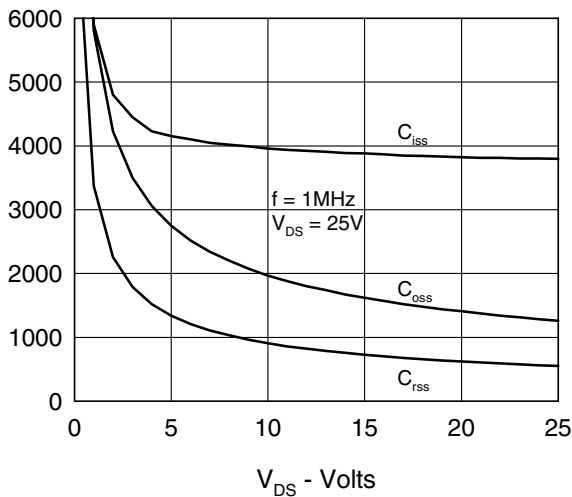

Fig.9 Capacitance Curves

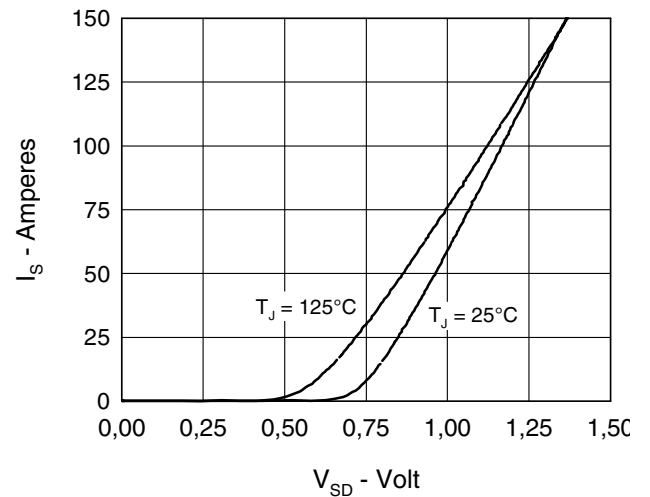

Fig.10 Source Current vs. Source to Drain Voltage

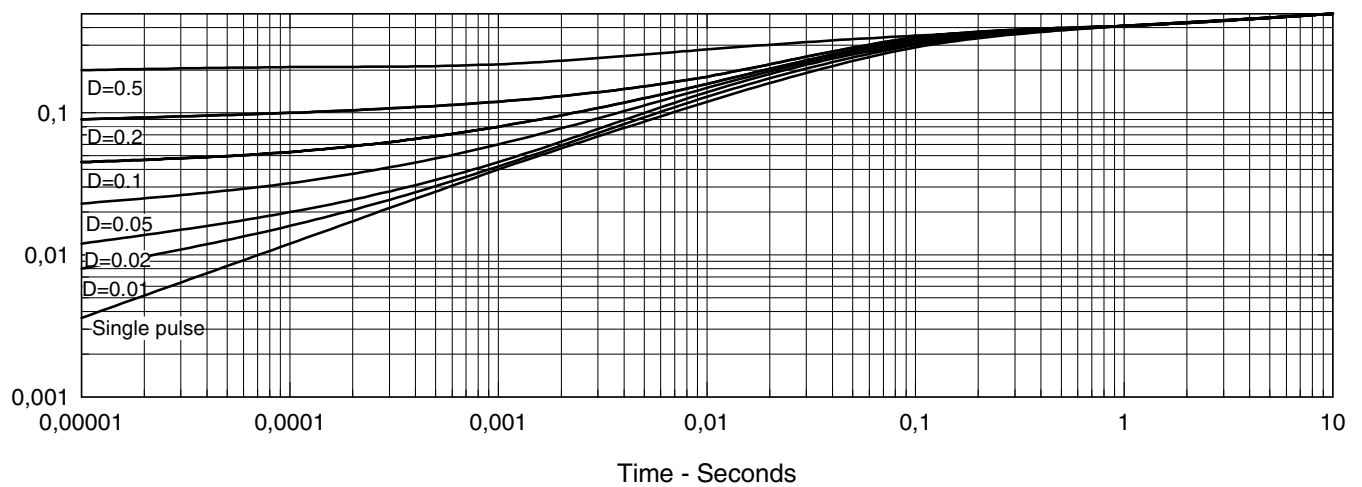

Fig.11 Transient Thermal Impedance